

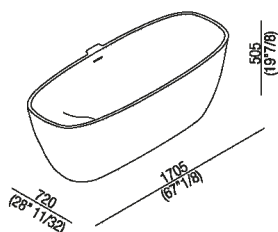

Vasca
 AVAS0910_

Benedini Associati, 2008

Vasca free-standing in Cristalplant®
 biobased di dimensioni contenute.



Vasca in Cristalplant® biobased bianco o bicolore (esterno grigio scuro RAL7021 o grigio chiaro RAL7044); con foro per troppo pieno, senza fori per rubinetteria; questa può essere collocata a parete o a terra. È obbligatorio l'utilizzo della piletta sifonata .MET0477 o .MET0477C (.MET0434 o .MET0477C per vasche in esposizione). La versione bicolore può essere realizzata con colore indicato dal cliente con maggiorazione del 15% sul costo della finitura bicolore. Per un'installazione più agevole, si suggerisce l'utilizzo del pozzetto per vasca AKITPZVAS.

Finiture



Bianco



Bianco/grigio scuro



Bianco/grigio chiaro

Materiali



Cristalplant® biobased

Altezza:	50.5 cm	19" 7/8 inches
Lunghezza:	170.5 cm	67" 1/8 inches
Peso:	76 kg	168 lbs
Profondità :	72 cm	28" 11/32 inches
Capacità:	273 l	72 gal
Confezione:	100 x 200 x 82 cm	39" 3/8 x 78" 3/4 x 32" 1/4 inches
Peso della confezione:	134 kg	295 lbs



Dimensioni principali

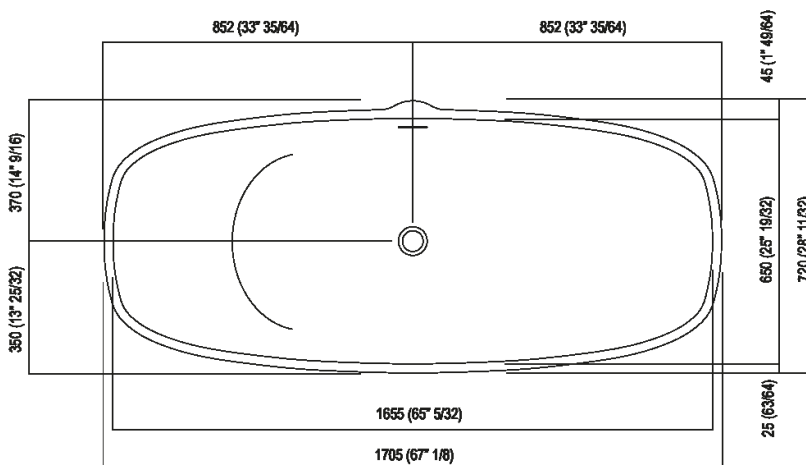
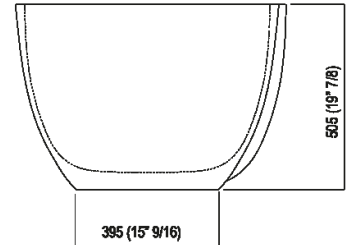
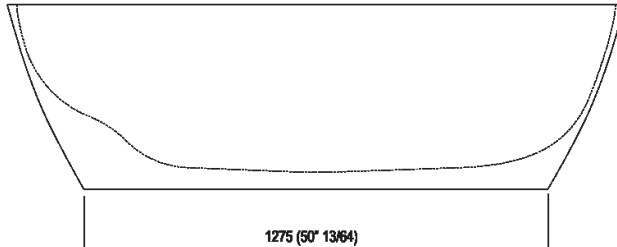



Quote per pozzetto

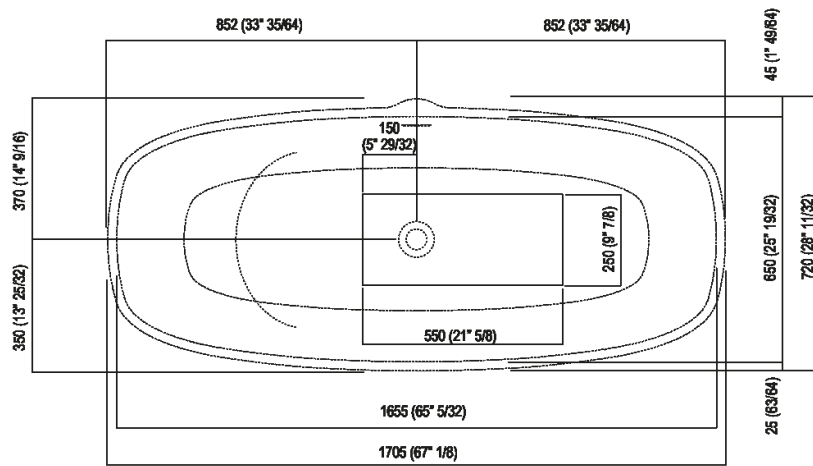



Quote per rubinetteria a parete

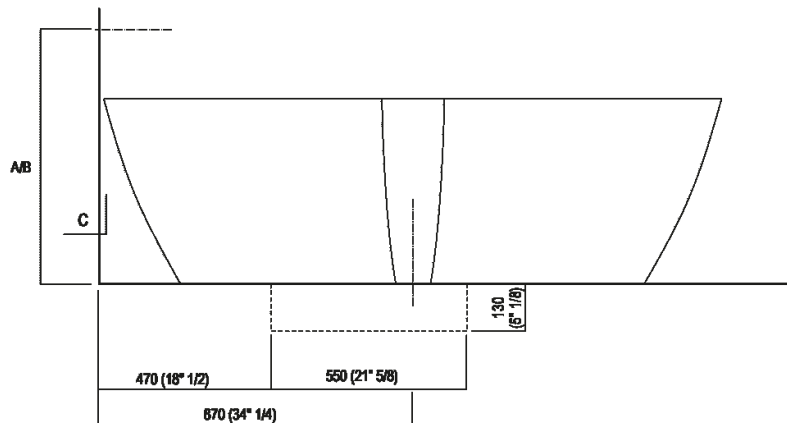
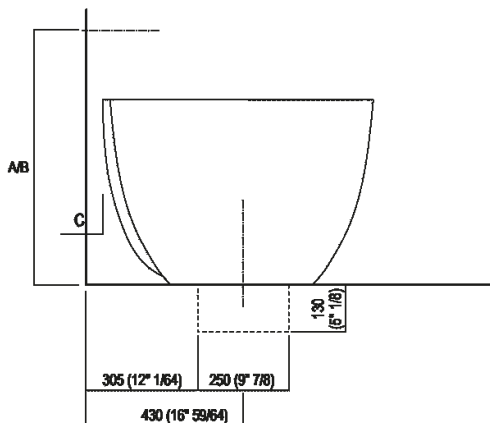

	A*	B**	C
FEZ 2 (EFEZ027)	700 (27 ¹ / ₂)	-	80 (3 ⁵ / ₃₂)
LIMÓN (ELIM443)	700 (27 ¹ / ₂)	-	80 (3 ⁵ / ₃₂)
MEMORY (EMEM324, EMEM343)	700 (27 ¹ / ₂)	-	80 (3 ⁵ / ₃₂)
(EMEM342)	700 (27 ¹ / ₂)	-	50 (1 ³¹ / ₃₂)
MEMORY MIX (EMEM437)	700 (27 ¹ / ₂)	-	50 (1 ³¹ / ₃₂)
SQUARE (ERUB1117)	-	700 (27 ¹ / ₂)	50 (1 ³¹ / ₃₂)
(ERUB1118)	-	700 (27 ¹ / ₂)	80 (3 ⁵ / ₃₂)
SEN (ASEN0912V)	-	700 (27 ¹ / ₂)	50 (1 ³¹ / ₃₂)

* **innesco gruppo / axial distance for tap**
 ** **filo inferiore gruppo / Tap's lower edge**



Quote per piantane da terra

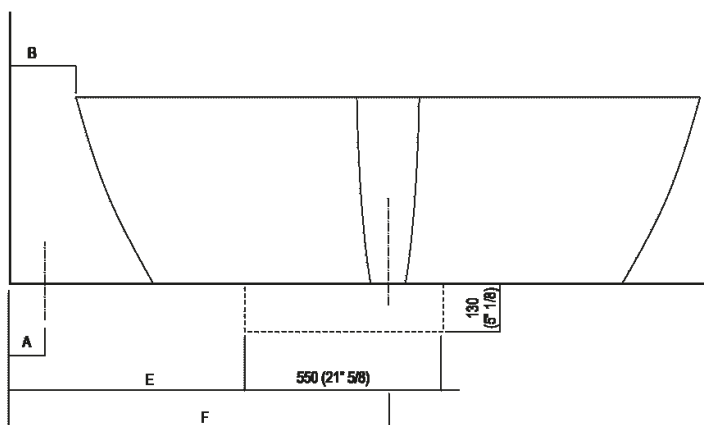
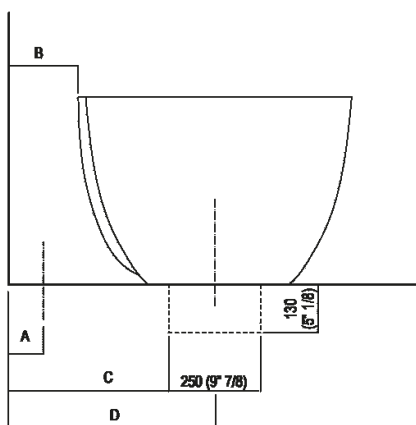

	A	B	C	D	E	F
FEZ 2 (EFEZ026, MET885) (EFEZ028)	90 (3 ³⁵ / ₆₄) 135 (5 ⁵ / ₁₆)	180 (7 ³ / ₃₂) 210 (8 ¹⁷ / ₆₄)	435 (17 ¹ / ₈) 470 (18 ¹ / ₂)	560 (22 ³ / ₆₄) 595 (23 ²⁷ / ₆₄)	620 (24 ¹³ / ₃₂) 650 (25 ¹⁹ / ₃₂)	1020 (40 ⁵ / ₃₂) 1050 (41 ¹¹ / ₃₂)
LIMÓN (ELIM425)	135 (5 ⁵ / ₁₆)	210 (8 ¹⁷ / ₆₄)	470 (18 ¹ / ₂)	595 (23 ²⁷ / ₆₄)	650 (25 ¹⁹ / ₃₂)	1050 (41 ¹¹ / ₃₂)
MEMORY (EMEM325)	135 (5 ⁵ / ₁₆)	210 (8 ¹⁷ / ₆₄)	470 (18 ¹ / ₂)	595 (23 ²⁷ / ₆₄)	650 (25 ¹⁹ / ₃₂)	1050 (41 ¹¹ / ₃₂)
MEMORY MIX (EMIX425)	135 (5 ⁵ / ₁₆)	210 (8 ¹⁷ / ₆₄)	470 (18 ¹ / ₂)	595 (23 ²⁷ / ₆₄)	620 (24 ¹³ / ₃₂)	1020 (40 ⁵ / ₃₂)
LIMÓN / MEMORY / MEMORY MIX (EMEM327)	90 (3 ³⁵ / ₆₄)	180 (7 ³ / ₃₂)	435 (17 ¹ / ₈)	560 (22 ³ / ₆₄)	620 (24 ¹³ / ₃₂)	1020 (40 ⁵ / ₃₂)
SQUARE (ERUB1112, ERUB1115)	90 (3 ¹ / ₈)	180 (7 ³ / ₃₂)	435 (17 ¹ / ₈)	560 (22 ³ / ₆₄)	620 (24 ¹³ / ₃₂)	1020 (40 ⁵ / ₃₂)
SEN (ESEN0911, ESEN0977)	90 (3 ³⁵ / ₆₄)	140 (5 ³³ / ₆₄)	365 (14 ³ / ₈)	490 (19 ¹⁹ / ₆₄)	590 (23 ¹⁵ / ₆₄)	990 (38 ³ / ₃₂)



Quote per colonna porta rubinetteria

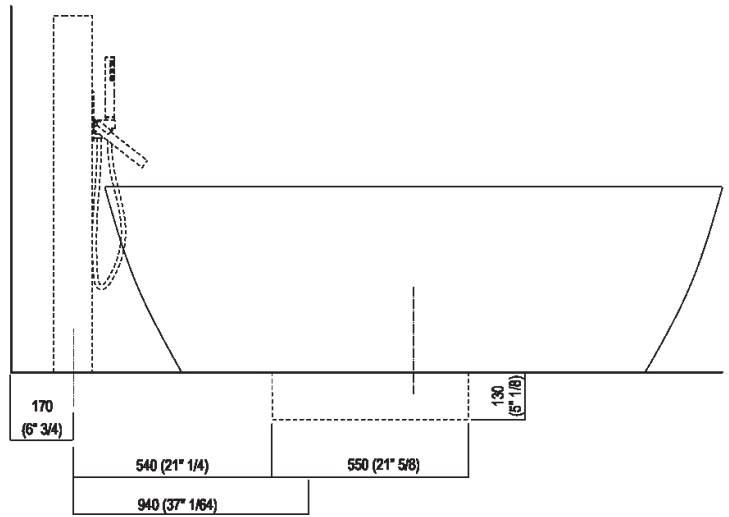
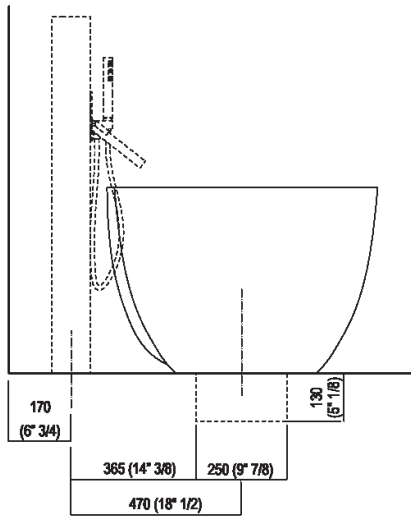



Nota

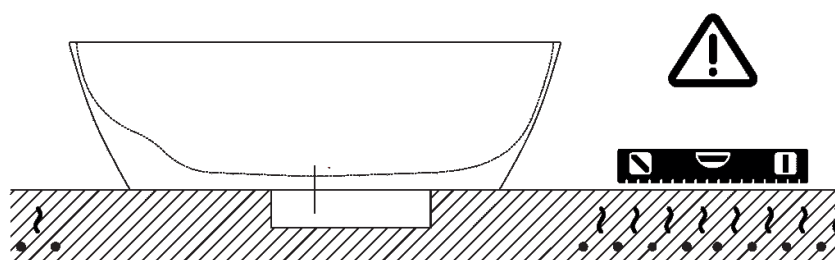

**La vasca deve essere installata su un pavimento perfettamente piano.
The bathtub must be positioned on a flat floor surface.**

**E' necessario predisporre a pavimento un pozzetto.
It is necessary to prepare a recess in the floor.**

**Evitare di realizzare impianti di riscaldamento nell'area sottostante la vasca.
Avoid the installation of floor heating plants in the area under the bathtub.**